

Equipment  
Guide

**BEC**

NEW · USED · RENTALS · PARTS · SERVICE

# Rely On Brown

## Keeping you on the job.

Our goal is simple. Keep our customers on the job. Locally owned, Brown Equipment Company is a consumer-driven dealership that focuses on providing the right solutions and unparalleled service to our customers. We partner with innovative manufacturers to deliver a robust, comprehensive selection of products to meet a variety of customer needs. From heavy equipment to traffic safety signs, to remote-operated mowers, to wireless communication, BEC is honored and proud to be a knowledgeable resource for product sales and support always striving for the best customer experience.















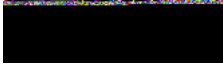

## New, Used, Rentals, Parts & Service

- Sewer Equipment
- Street and Highway Equipment
- Highway Safety and Traffic Control
- Air and Hydro Excavators
- Manhole and Safety Equipment
- Multi-use Tractors
- Locators
- Diagnostics & Drain Cleaning
- Camera Inspection Systems

**BrownEquipment.net**  
**(800) 747-2312**

	IN	KY	OH	MI
	✓	✓	✓	
	✓	✓		
<b>BUCHER municipal</b>	✓	✓		
	✓	✓	✓	✓
	✓	✓		
<b>Sonetics</b>	✓	✓	✓	✓
	✓			
	✓	✓	✓	✓
<b>WANCO</b>	✓	✓	✓	✓
	✓	✓	✓	✓
	✓	✓	✓	
	✓	✓		
	✓	✓	✓	✓
	✓	✓	✓	✓
<b>RADIODETECTION</b>	✓	✓	✓	✓
<b>SCHONSTEDT</b>	✓	✓	✓	✓

# Table of Contents

	Street Sweepers	4
	Street Sweepers	6
	Seasonal & Road Maintenance	8
	Remote Control Slope Mowers	10
	Traffic Safety Signs	11
	Multi-purpose Tractors	12
	Diagnostics & Drain Cleaning	14
	Camera Inspection Systems	16
	Locators	18
	Valve Maintenance Systems	19
	Jetters & Easement Machines	20
	Combination Sewer Cleaners	22
	Vacuum Excavators	26
	Specialty Sewer Machines	28
	Sewer Cleaning Nozzles	30
	Vanguard System	31
	Manhole & Safety Equipment	32
	Rental Equipment	34
	Camera Services	36
	Full-Maintenance Service & Repairs	38
	Reconditioning	40
	Custom Builds & Fabrication	42
	Parts & Accessories	43

# Street Sweepers



## Global® Street Sweepers

Purpose built, heavy duty and simply tough street sweepers.

Models	
<p><b>M3</b></p> <p>Sweeping speed up to 9mph Travel speed up to 24mph 130HP Cummins engine</p>	<p><b>M4</b></p> <p>Sweeping speed up to 11mph Travel speed up to 67mph 280HP Cummins engine</p>

### Turning Radius

**M3 | R3**



**M4 | M4HSD | R4**



**9' 6"  
rear high  
dump**

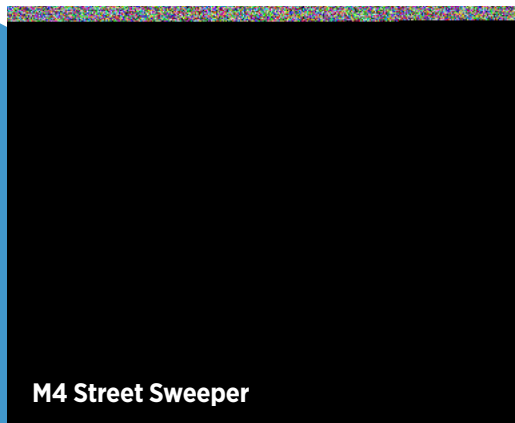
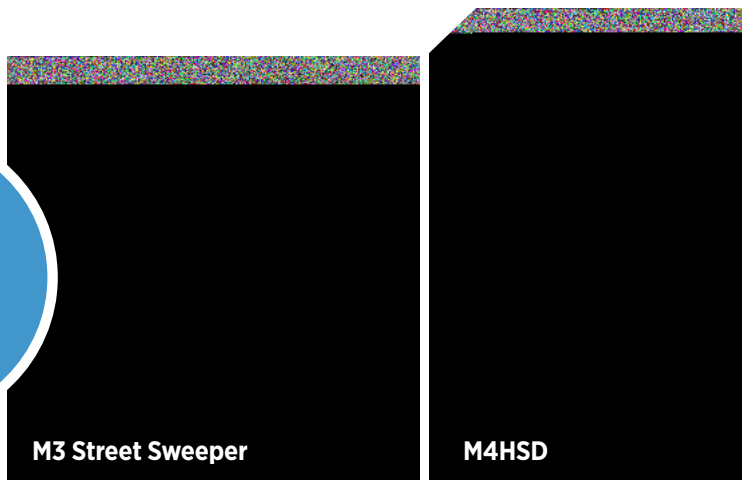

**Optional 100% stainless steel  
hopper with lifetime warranty**

M3 Street Sweeper

**Only  
Class 7 100%  
electric street  
sweeper in  
the USA**

**M4 Electric | 9-11 hours operational time**

Models
<p><b>Global M3CNG</b> Sweeping speed up to 9mph</p>
<p><b>Global M4CNG</b> Sweeping speed up to 9mph</p>
<p><b>Global M4 Hybrid</b> Travel speed up to 60mph Over 50% increase in fuel economy</p>
<p><b>Global M3 Electric Sweeper</b> Sweeping speed up to 11mph Travel speed up to 25mph</p>
<p><b>Global M4 Electric Sweeper</b> Sweeping speed up to 11mph Travel speed up to 60mph</p>

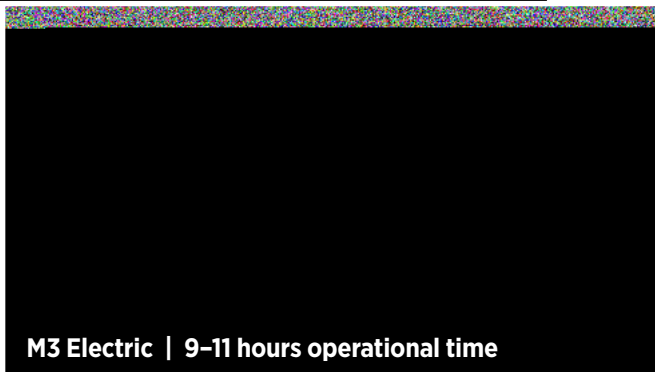

**Global® M3EV & M4EV Street Sweepers**

- Zero CO<sub>2</sub> Emissions to reduce global pollution
- Up to 10-year battery life
- 9-11 hours operational time

**MADE IN THE USA** 

# Street Sweepers

**BUCHER**  
municipal

## Bucher Municipal V65 Range Truck Mounted Sweepers

All-inclusive warranty (2 years/2,000 hours)

- 8.5 yd<sup>3</sup> hopper capacity
- 410 gal water tank
- Complete hopper constructed of 9 ga stainless steel: 250-times better corrosion resistance than standard or even 304 stainless steel
- Low Environmental Impact: Reduces water usage by 20% with ability to save up to 237 gal of water per day
- Available with a single engine, twin engine, or hydrostatic engine.

Lifetime  
warranty  
on entire  
hopper  
body

V65

V65t

CityCat 5006

## Bucher Municipal CityCat Compact Street Sweeper

- Water capacity 232 gal
- Hydrostatic-controlled four-wheel steering
- Up to 31 mph traveling speed
- 7.3 yd<sup>3</sup> hopper volume
- Stainless steel hopper construction

**9' 8"**  
**turning**  
**radius**

# Seasonal & Road Maintenance



## Leaf Collectors

- 1 person operation
- 17, 25, or 30 yd<sup>3</sup> hopper availability
- 6 way hydraulic hose boom controlled by an in-cab joystick

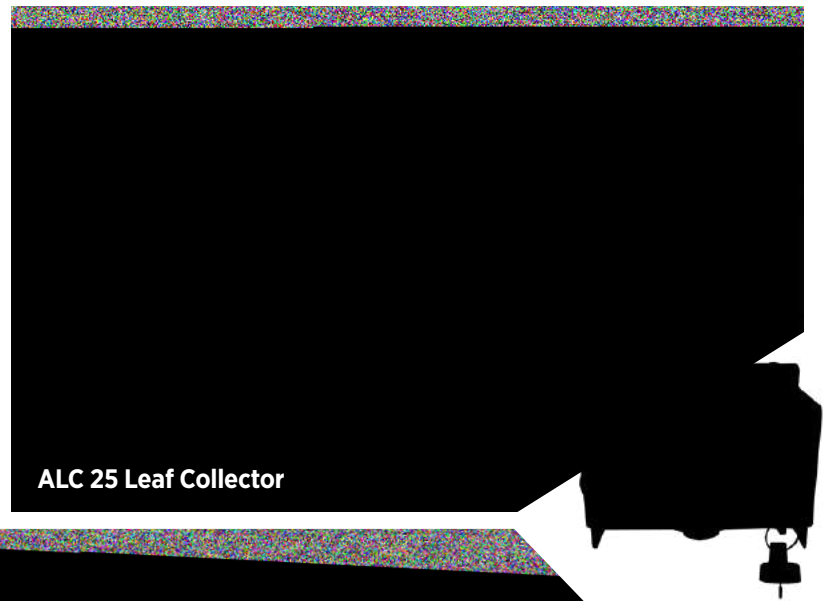

ALC 25 Leaf Collector





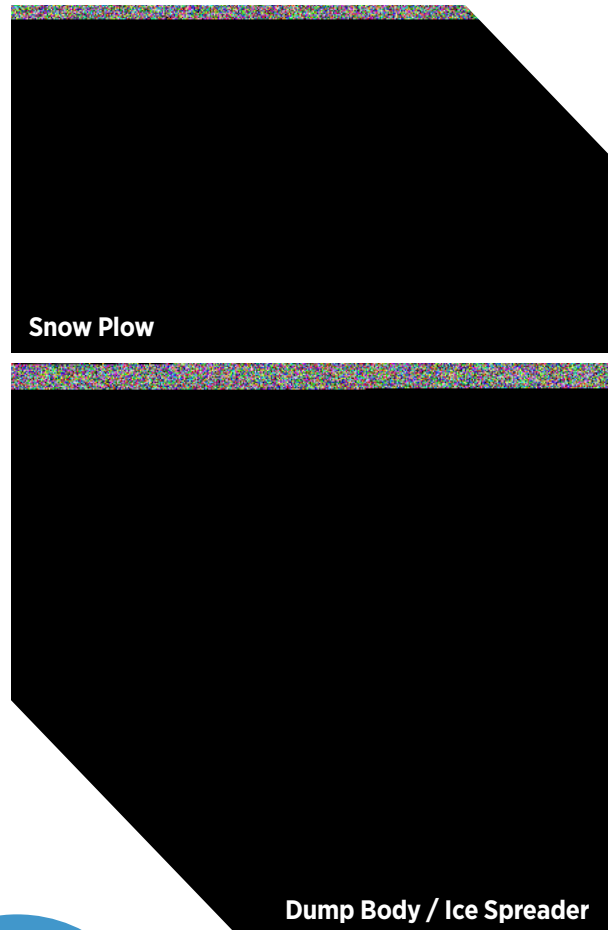
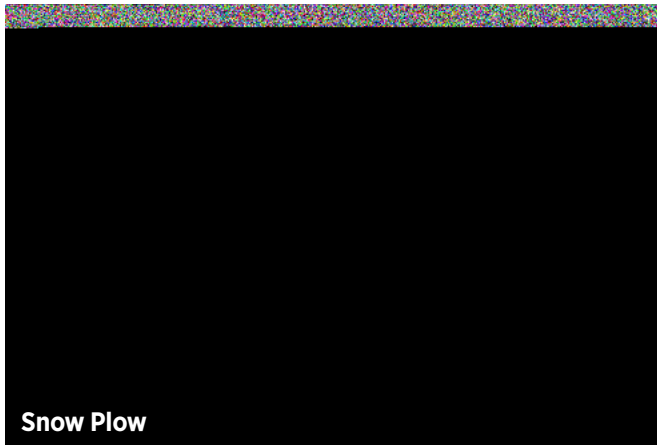

## Snow and Ice Management

Complete line of heavy duty snowplow systems and integrated custom upfit solutions can service city streets, rural roads and interstate highways.



## Spaulding Hot Patchers

Optional fully oil jacketed hopper

-  Heavy duty steel construction
-  Fully insulated
-  Even thermal heat
-  Gravity fed design
-  Spring loaded top doors
-  Options



# Remote Control Slope Mowers

- Low center of gravity and wide base allow for safely mowing slopes up to 50°
- Extremely low ground pressure ideal for soft, wet terrain
- Remote-control connectivity up to a range of 1,000 ft
- No special operator certification
- 20-hour run time
- 30-day money back guarantee
- 72-hour parts shipping guarantee



**RC MOWERS**  
TK Track Models

**RC MOWERS**  
Wheeled Models

Specialty Slope Mowers

Weighted Tractor

Conventional Zero Turns

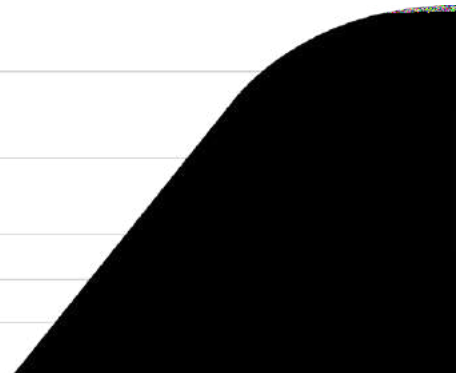

Each RC Mower includes a commercial grade remote allowing safe operation up to 1,000 ft away.

# Traffic Safety Signs



## Variable Message Boards



## Arrow Board Trailers

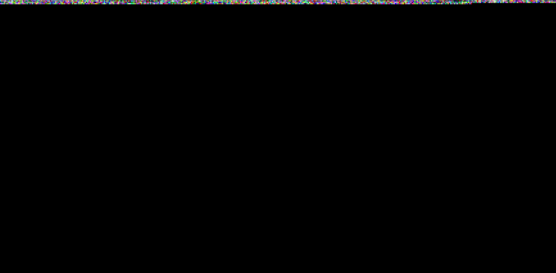

Vertical Trailer

Folder Trailer

## Modems

The Wanaco Modem Package with GPS provides remote access and control to Wanaco Message Signs using an Internet-connected computer, tablet or smartphone. Remote access saves time, improves safety and provides up-to-date information.



## Light Tower



Diesel, Vertical Tower  
WLTV

Diesel, Laydown Tower  
WLT

## Additional Options

- Arrow board skirts
- Truck mount arrow boards
- Balloon light
- Solar light towers
- Portable camera trailers
- Radar-speed signs
- Fold-n-go portable sign trailers
- X-markers

# Multi-purpose Tractors

- 360° unrestricted cabin view
- First class comfort with full independent spring and damper suspension
- Incredibly simple operation
- Quick and easy change of attachments



**CV  
Sweeper**

# Diagnostics & Drain Cleaning

## **The Most Innovative System in the Industry.**

When problems are lurking in-pipe, behind walls or anywhere underground, more professionals choose RIDGID drain cleaning, diagnostics, locating and thermal imaging tools than any other brand. That's because RIDGID sets the industry standard for ease of use, durability and advanced functionality. Every tool is purpose-built based on feedback from professionals in the field and backed by one of the best warranties in the industry. Build your business with the most complete system of professional inspection, diagnostic, thermal imaging and drain cleaning tools available. See it. Find it. Solve it.



RIDGID® GIVES YOU THE **COMPETITIVE EDGE.**

**RIDGID**<sup>®</sup>

---

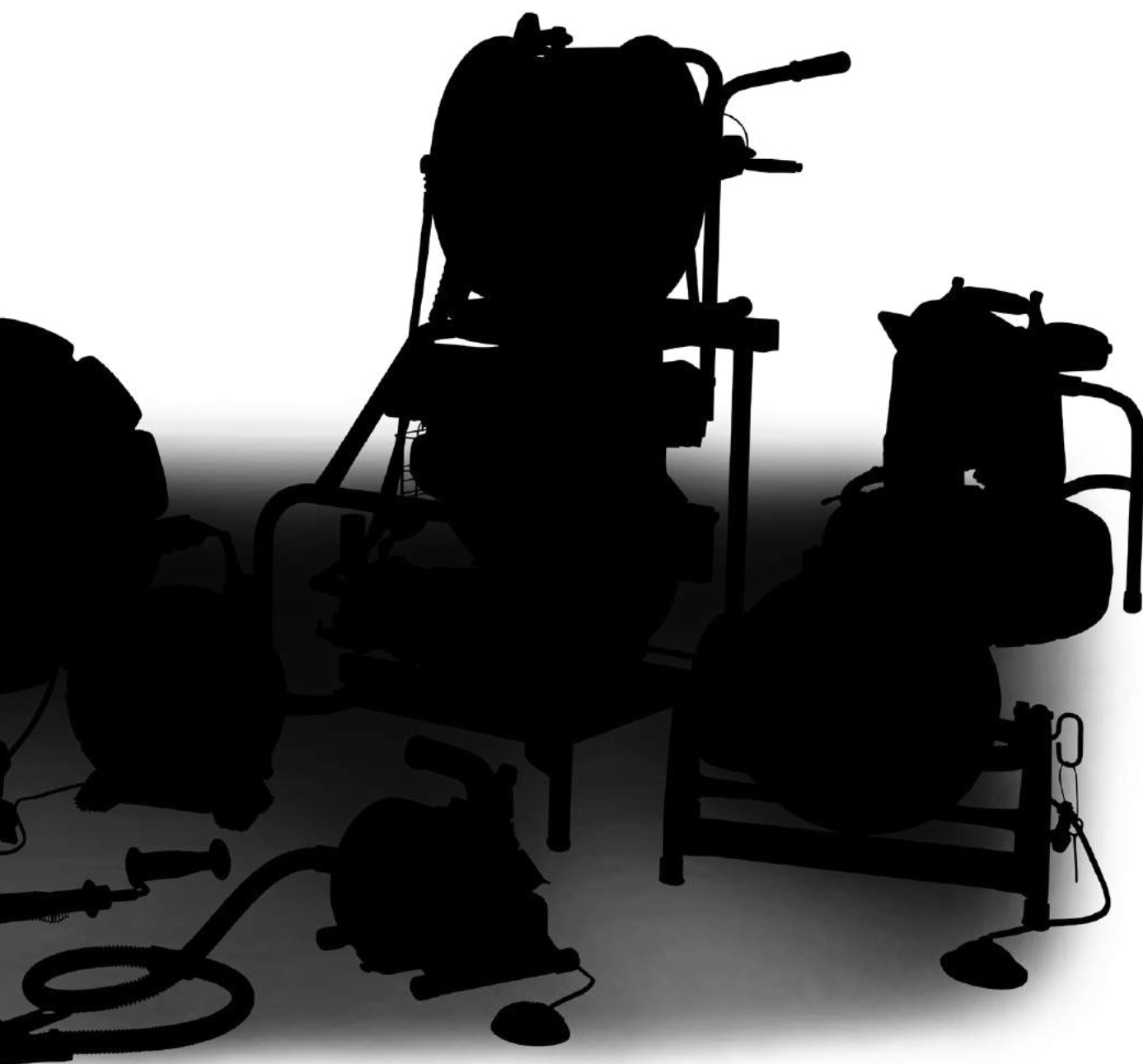

# Camera Inspection Systems

## CUES

- Unmatched loaner inventory for life of the equipment
- Service centers throughout the USA, including BEC's state-of-the-art facility in Indiana



CCTV Truck

CCTV Transit Van

CCTV Transit Van

C550c Hunter Base Station

"The Standard of the Industry"



## Micro Pan & Tilt

### Features

- White LED lighting
- Built-in lens wiper
- Detachable steering wand
- Self-leveling camera head
- Built-in sonde

# Manhole Inspection Systems

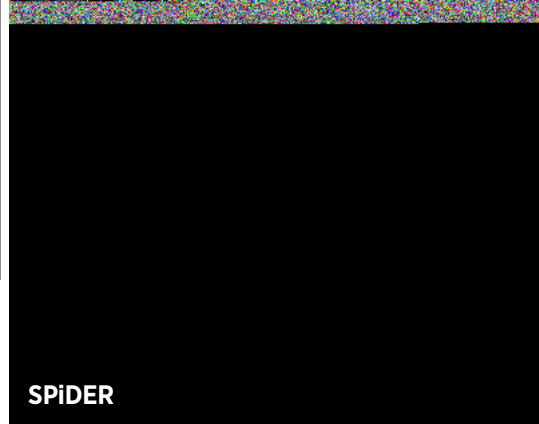
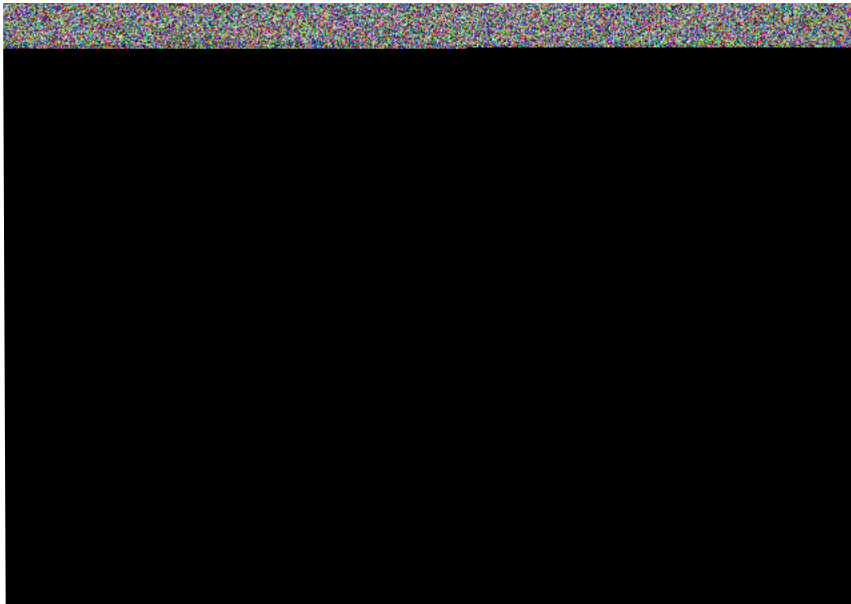

# Portable Systems

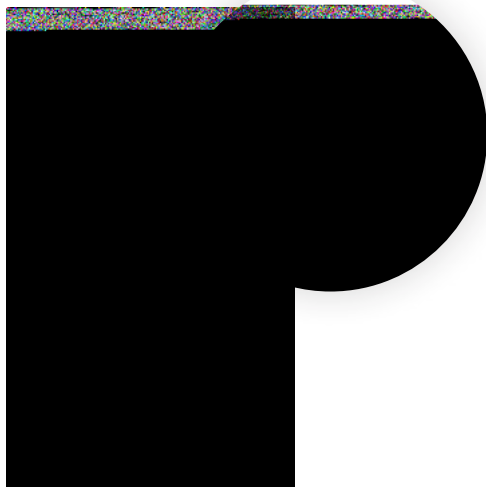
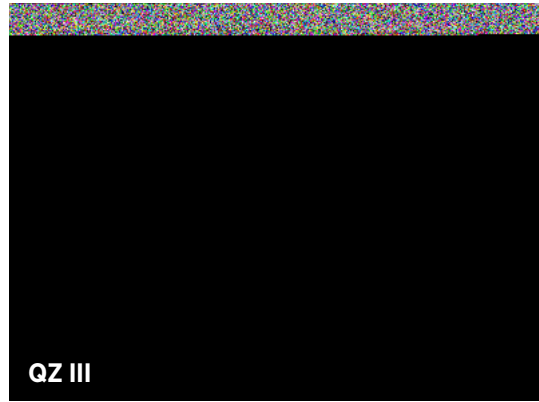

# Locators

## RADIODETECTION®



Local Support



Logistics



Training



Service

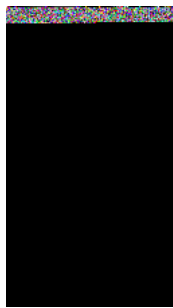

**RD7200**

Cable, Pipe and RF Marker Locator



**RD8200**

Cable, Pipe and RF Marker Locator

RD8200

## SCHONSTEDT®

### Magnetic Metal Locators

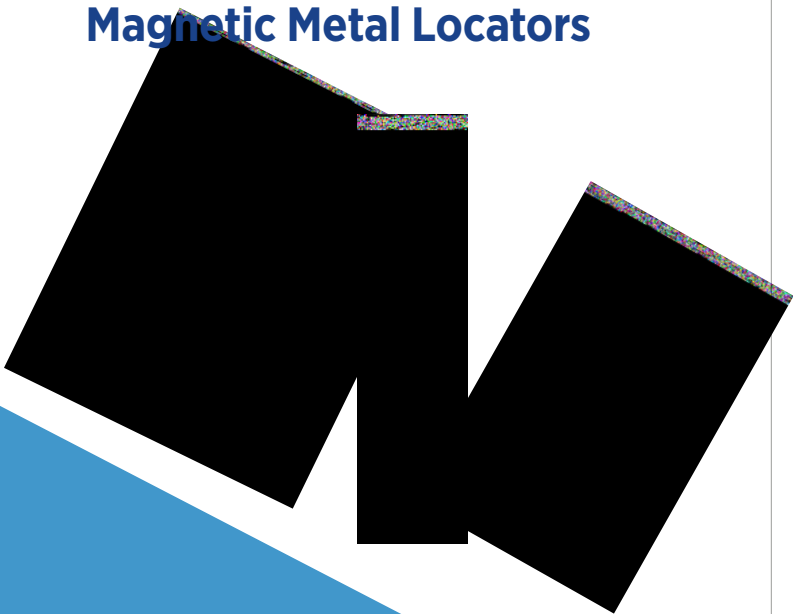

# Valve Maintenance Systems



- Curbside operation and control with optional wireless remote control
- System driven hydraulic, vacuum and pressurized water
- Vacuum with power operated debris tank
- Choice of ERV-750 or TM-7 valve exercisers
- Data storage and collection via VITALS software
- Class 2 hydraulics drive

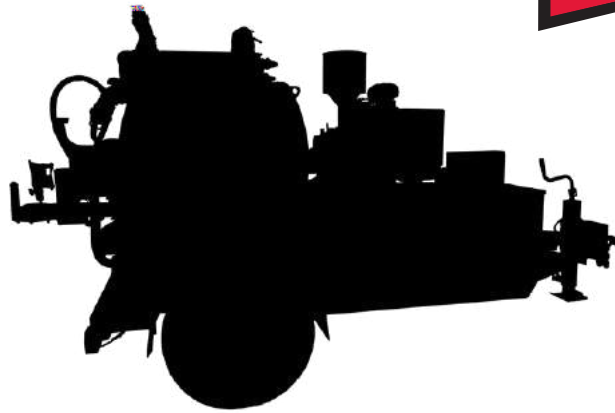

# Jetters & Easement Machines

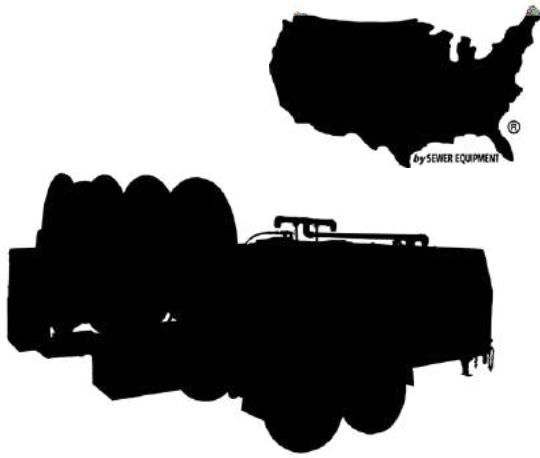

## 747 Trailer Jetter

- One piece enclosure
- Duraprolene water tank
- Box tube frame
- NEMA 4 wiring

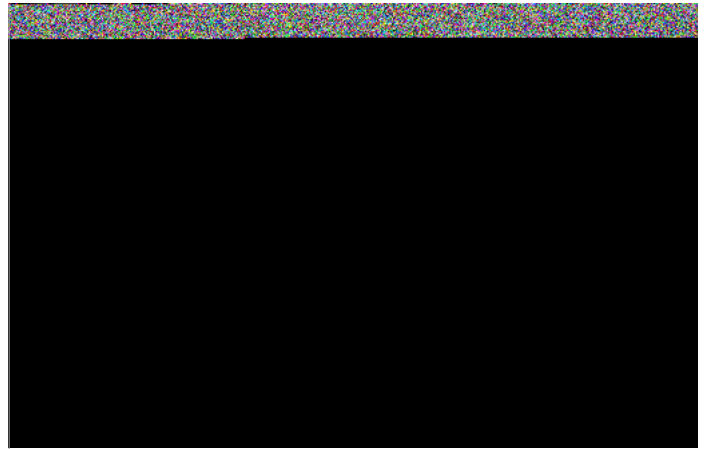

## Easement Machines

- Rotating hose reel
- Aluminum constructions
- Automatic level wind
- Track drive system approach

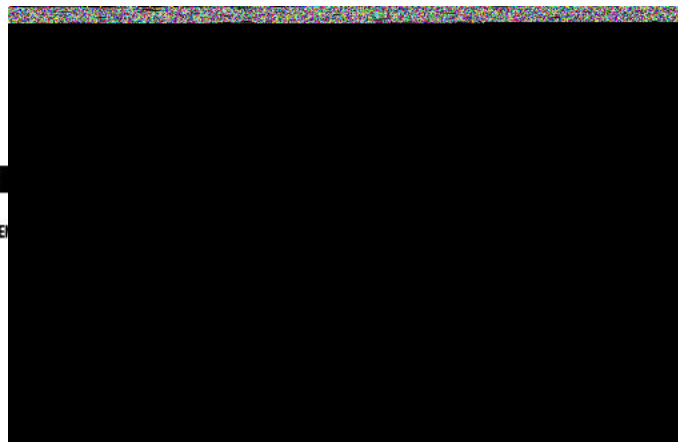

## Mongoose Jetter

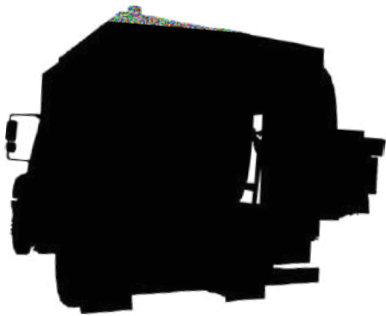
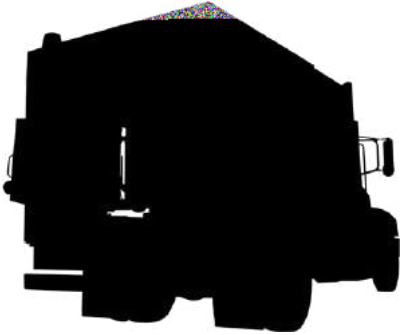
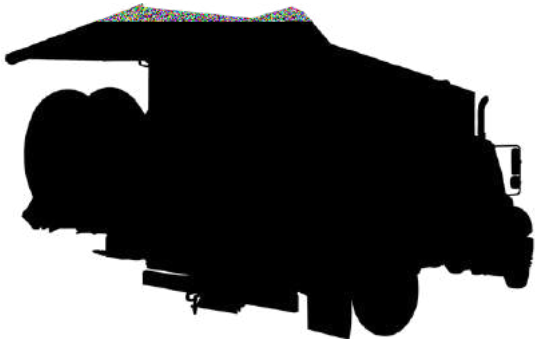

## 800 Truck Jetter

- Climate controlled environmental enclosure with 80,000 BTU heater
- ECO operating platform
- Rotating hose reel
- Small footprint
- Single and dual reel configuration
- Optional CUES camera jet pod system with TV monitor
- Rear door closure after extending the jet reel for maximum heat retention (Series IV)

### Water Tanks

Duraprolene tanks with fully-baffled interior

$\frac{3}{4}$ " Duraprolene water tanks

Rated 180 to -40 degrees for windchill

Water capacities from 1000 to 4500 gallons

# Combination Sewer Cleaners

Sewer Equipment of America - 900 ECO

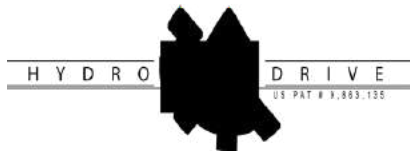

9 yard  
single  
axle

## Top Features

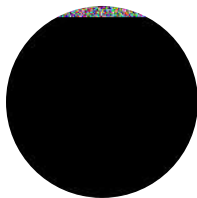

NO CHASSIS  
INTEGRATION

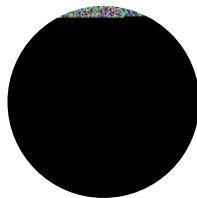

SIMPLE  
OPERATOR  
INTERFACE

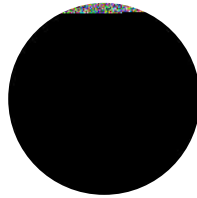

HYDRO DRIVE  
POWERTRAIN  
SYSTEM

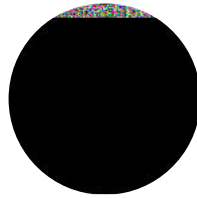

SIMPLE  
START UP

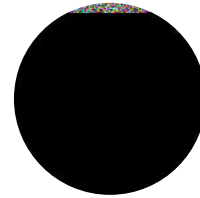

DURAPROLENE  
WATER TANKS

- Only single engine PD combo truck that runs in neutral
- Patented Hydro Drive system
- Standard Vac-on-the-Go
- 12-volt architecture with no computers or CAN Bus system
- Dig deep boom
- 3-stage air filtration system with dual 10-micron air filters
- 4" pump off system at 800 gpm with ability to pass up to a 3" solid

Water Tanks
½" Duraprolene water tanks
Rated 180 to -40 degrees for windchill

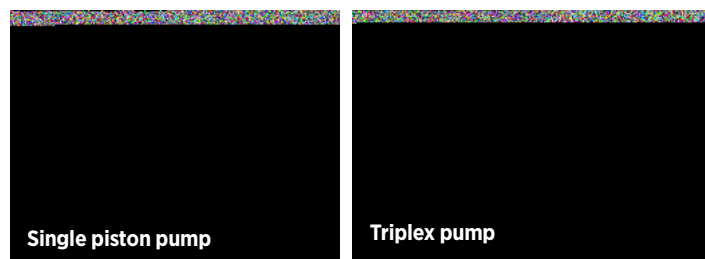

# 900 ECO Configurations

## 6 YARD 900 ECO WITHOUT BEHIND CAB TOOL BOX, TRIPLEX PUMP

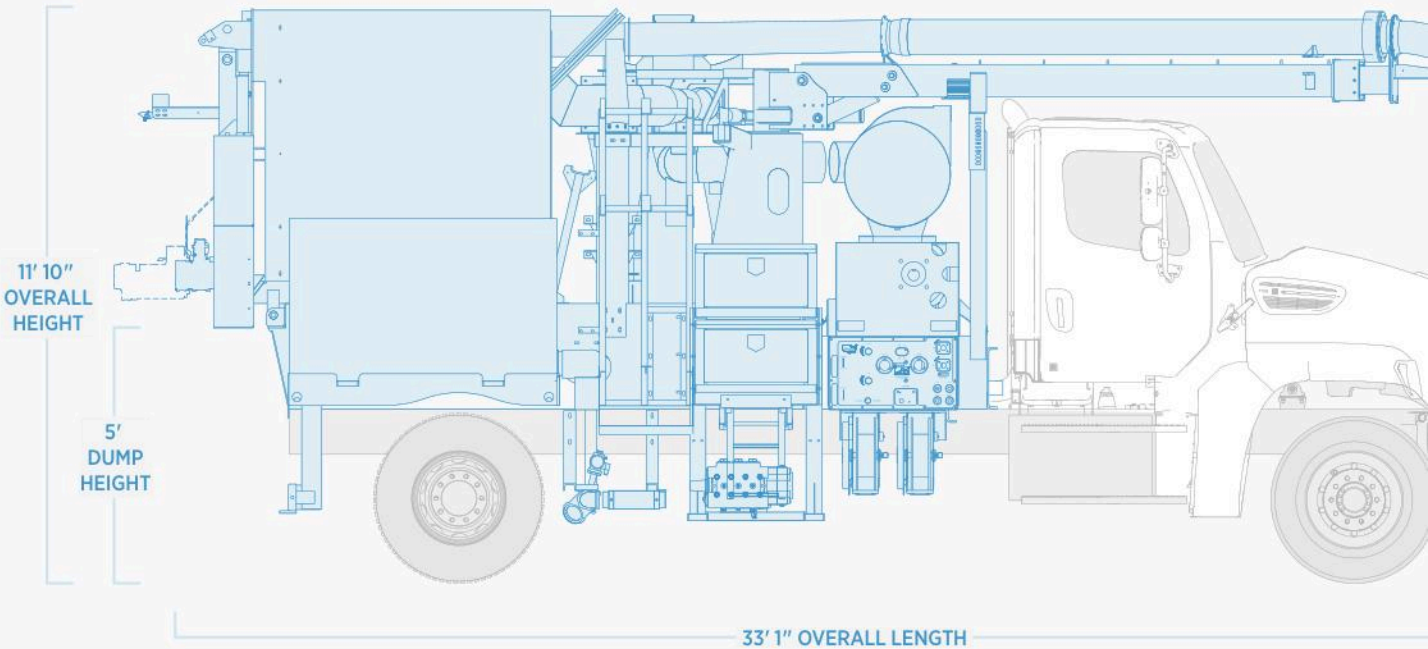

## 9 YARD 900 ECO WITHOUT BEHIND CAB TOOL BOX, SINGLE PISTON PUMP

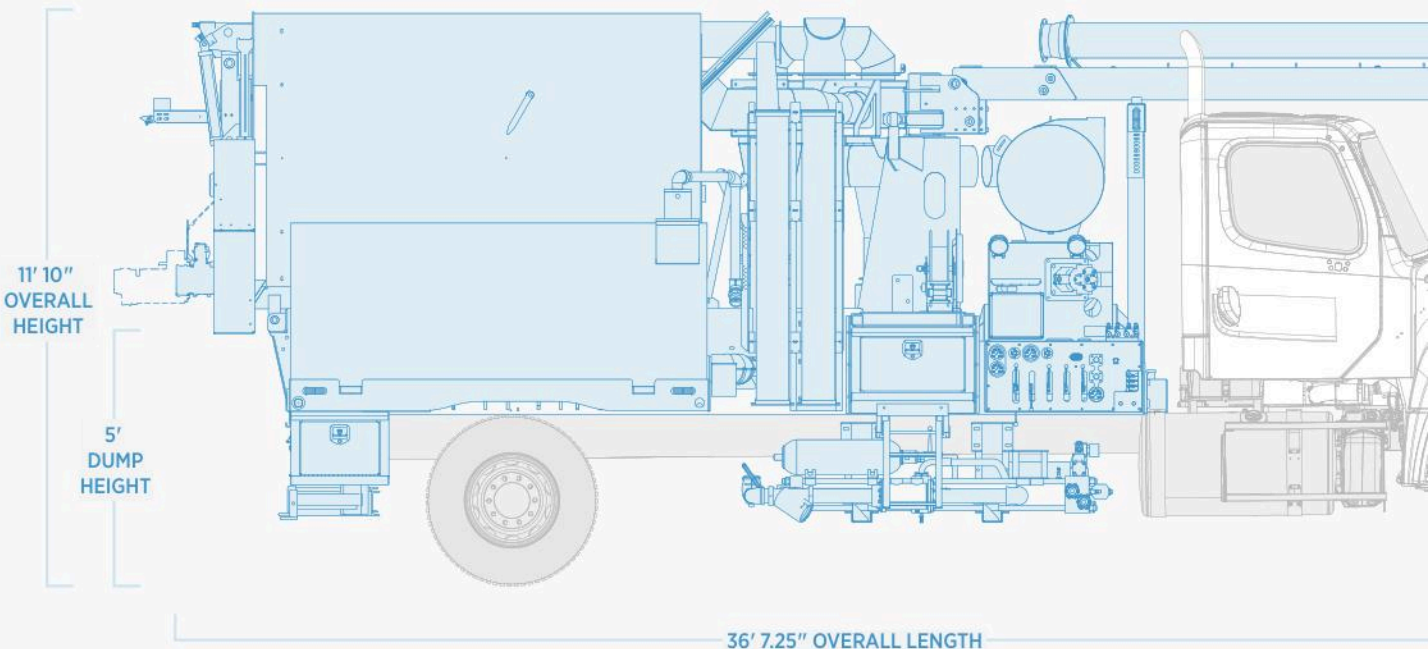

The 900 ECO is available in multiple sizes and configurations.

**6 YARD**

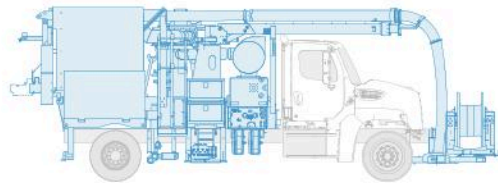

**9 YARD**

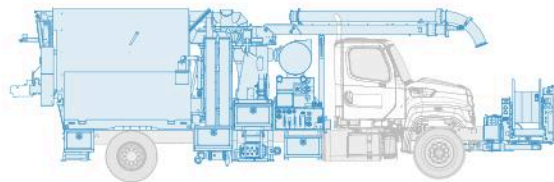

**12 YARD**

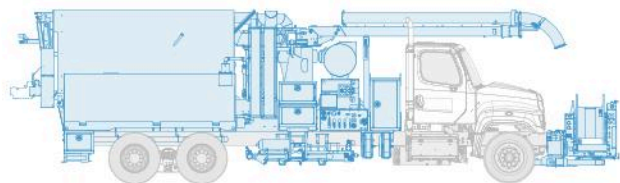

**15 YARD**

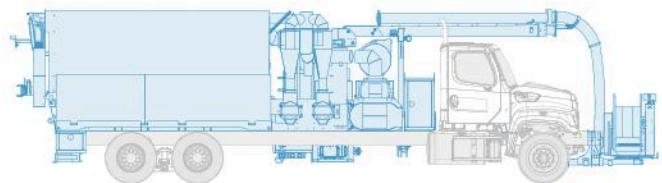

# Vacuum Excavators

## HX-12 Hydro Excavator

- 5 psi reversible blower
- 3-stage air filtration system with dual 10-micron air filters
- 4" pump off system at 800 gpm with ability to pass up to a 3" solid
- 100% enclosed water and hydraulic system
- Standard Vac-on-the-Go
- 12-volt architecture with no computers or CAN Bus system

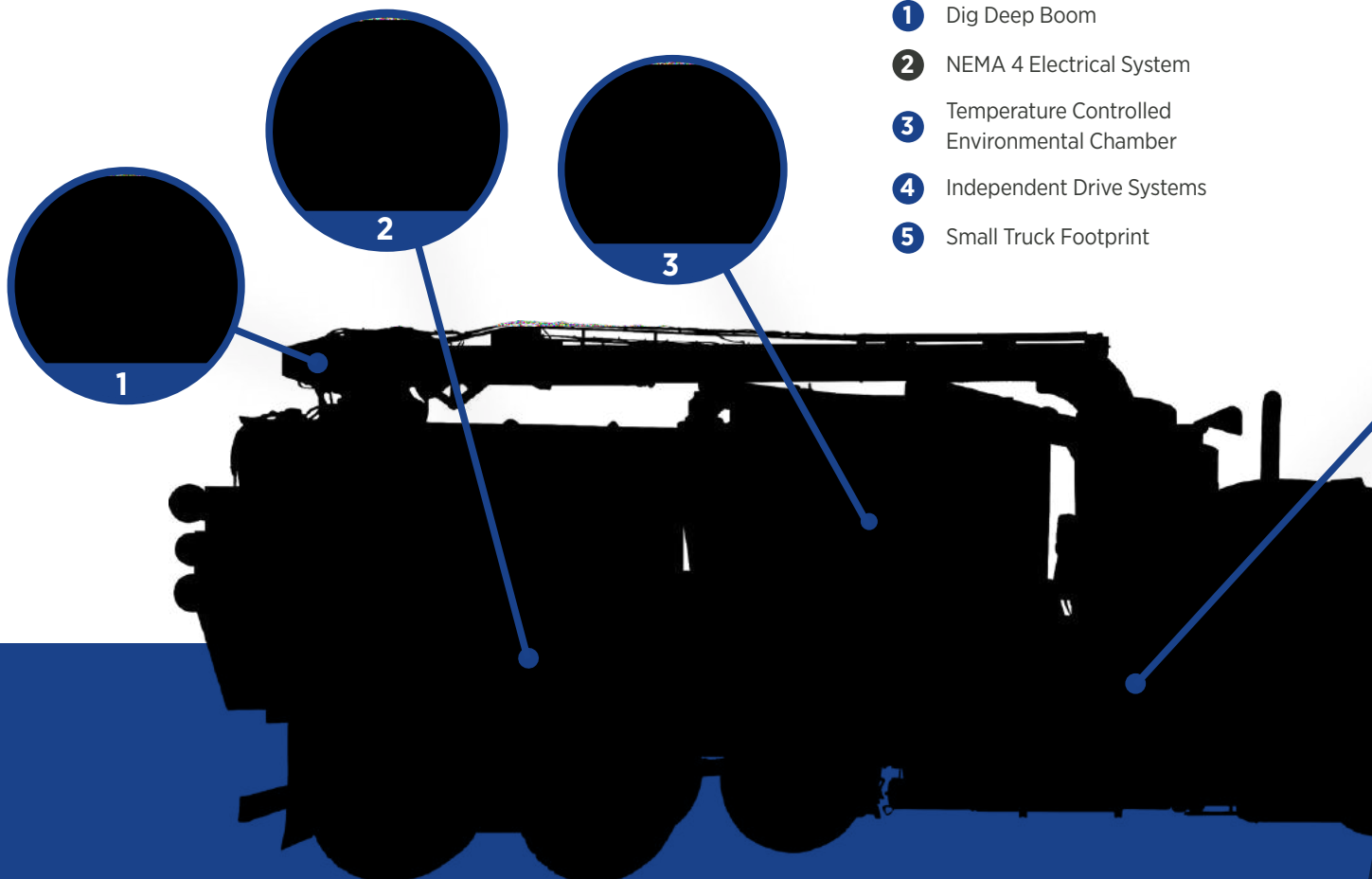
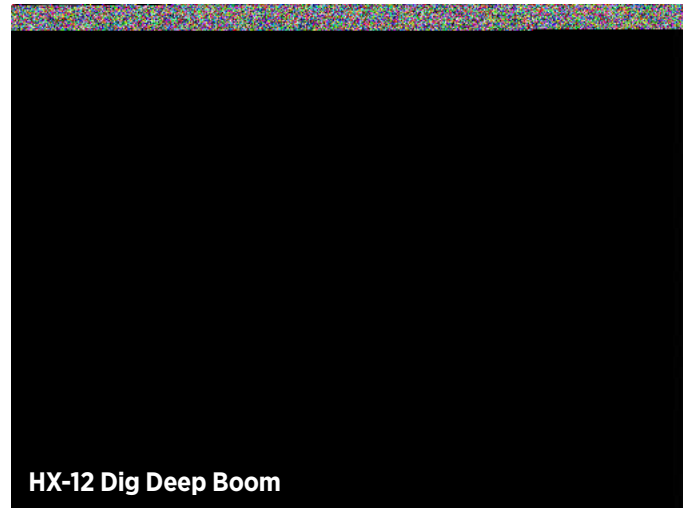

- 1 Dig Deep Boom
- 2 NEMA 4 Electrical System
- 3 Temperature Controlled Environmental Chamber
- 4 Independent Drive Systems
- 5 Small Truck Footprint



Water Tanks
3/4" thickness Duraprolene water tanks
Square design allows for increased water storage
Rated 180 to -40 degrees for windchill
Debris tank options from 3-15 yd <sup>3</sup>

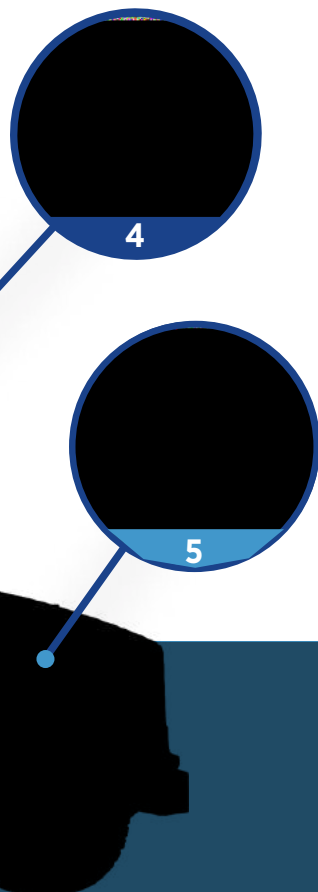
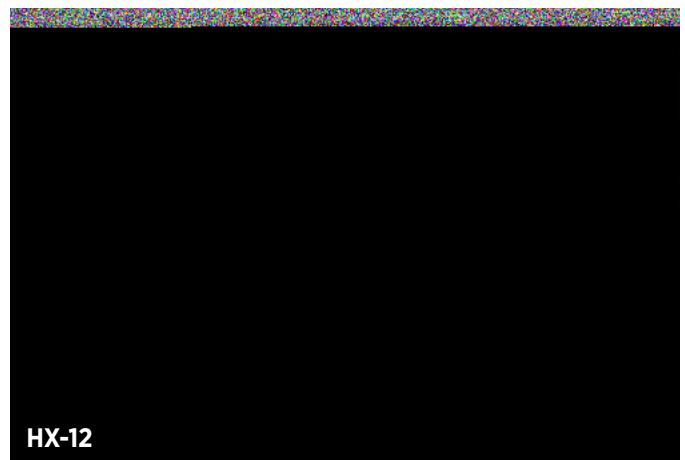

## Hydra-Flex Nozzles



# Specialty Sewer Machines



## Genesis Water Recycling Sewer Cleaner

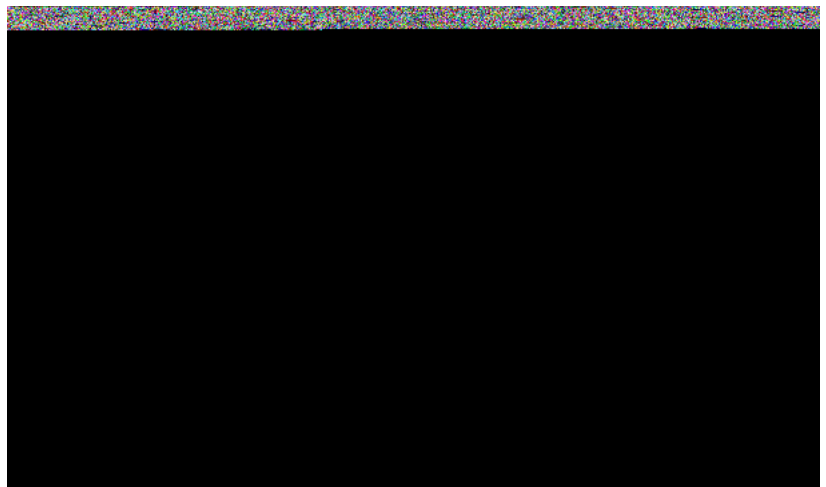

### 400 ECO

- Non CDL
- 4 yd<sup>3</sup>
- 600 gal water
- 28" PD blower
- Stainless steel construction

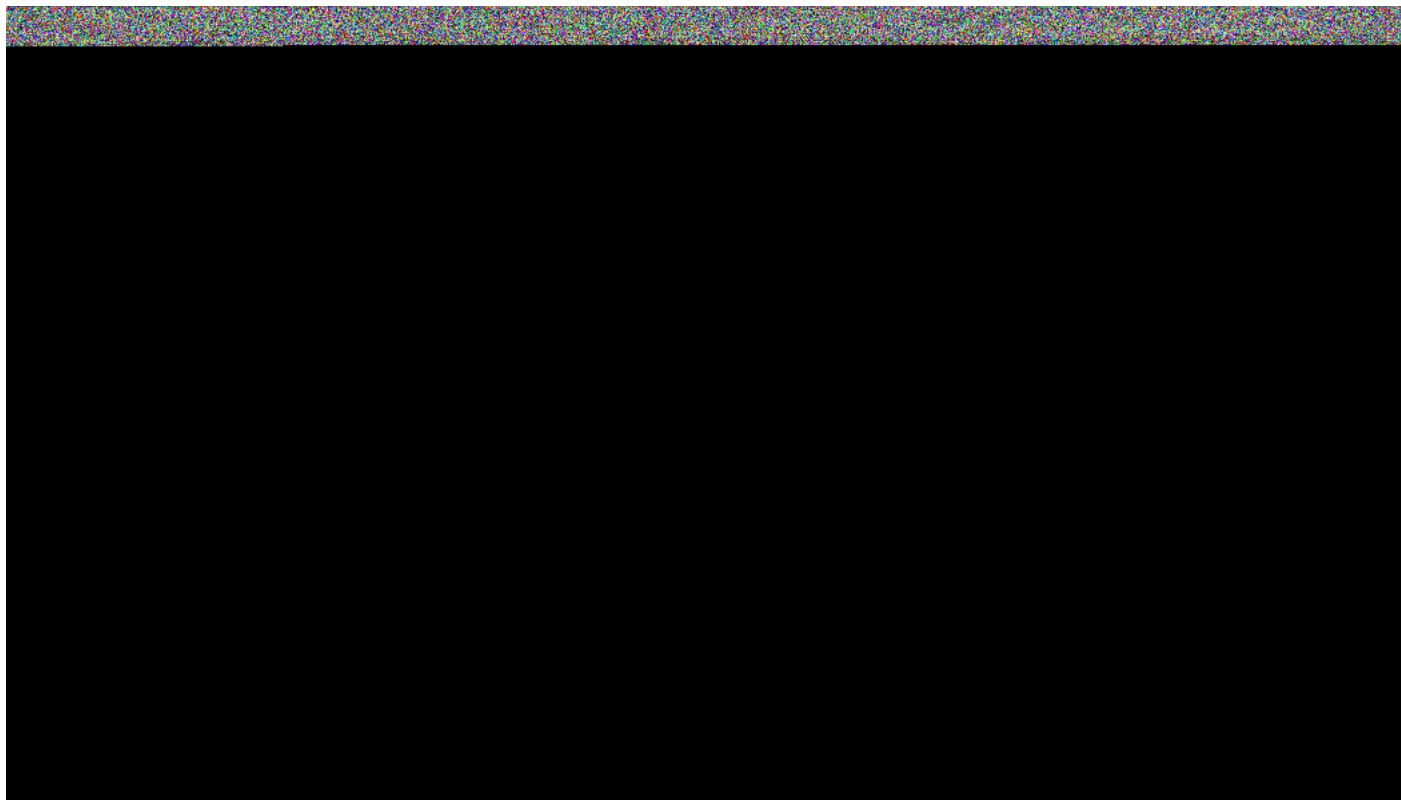

**AX-4000 Air Excavator**



**Catch Basin Cleaner**

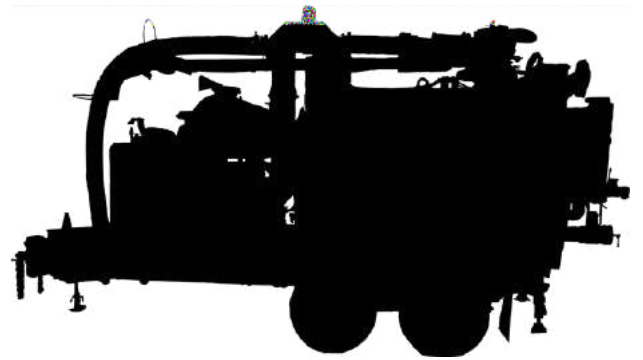

**Tempest Industrial Vacuum Loader**

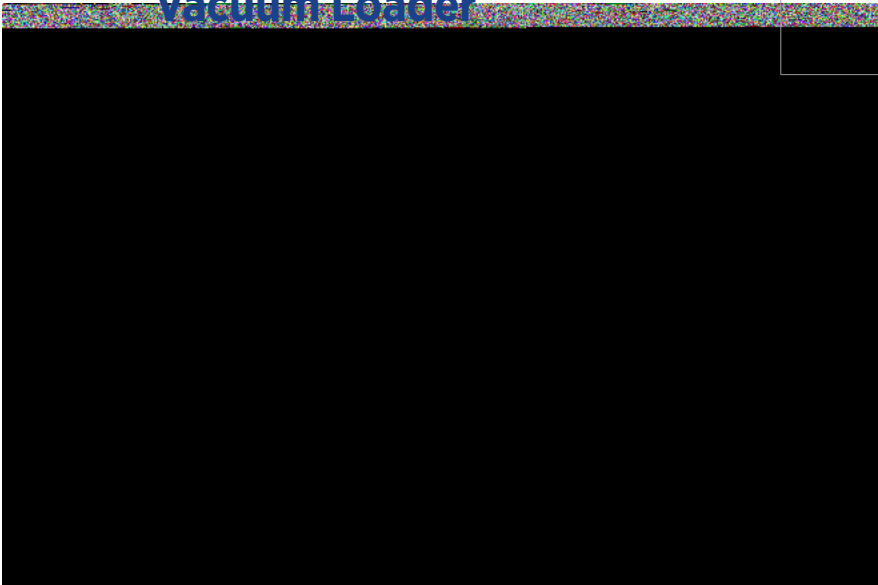

**Bucket Machine**



# Sewer Cleaning Nozzles



## CLEANING NOZZLES



RAMBO



TORPEDO



TRACTION



ALUMINUM

## NOZZLES

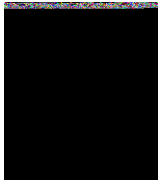

O.M.G.



AQUA POWER 700



EQUALIZER



HYDRO EXCAVATION

## CAMERAS



KLEEN SIGHT  
CAMERA SYSTEM



KLEEN SIGHT  
16"



KLEEN SIGHT  
NOZZLE BACK

## CUTTERS

### CHAIN CUTTER FAMILY

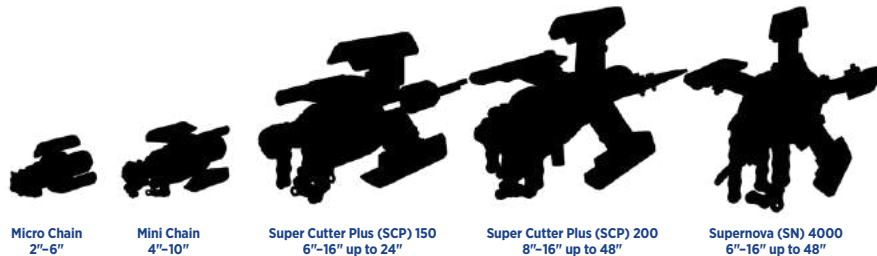

Micro Chain  
2"-6"

Mini Chain  
4"-10"

Super Cutter Plus (SCP) 150  
6"-16" up to 24"

Super Cutter Plus (SCP) 200  
8"-16" up to 48"

Supernova (SN) 4000  
6"-16" up to 48"

## FLOOR CLEANERS



BOTTOM CLEANERS



TWIN TEN JET FLOOR CLEANERS

# Vanguard System

Wastewater and raw sewage contain an abundance of dangerous bacteria, viruses, and parasites. The Vanguard Pathogen Defense System was developed to remove 98% of bacteria and viruses to help keep wastewater workers healthy.

**Easy to Use:** Click of a button to turn on or off

**Adjustable:** Spraying system with a 50' reach and provides water volume for SSO clean up

**Economical:** Few dollars per day to operate

**Easy to Install:** Installation on ANY make or model of combination, jet or CCTV truck

**Built to Last:** Lightweight and "NEMA 4" rated control box

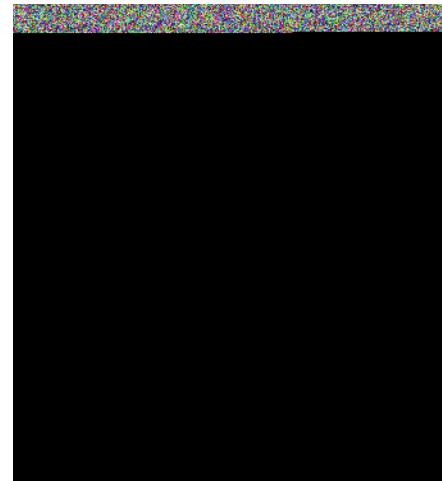

The patent pending Vanguard Spray Collar fits easily around most CCTV truck tubing.

- 1 Reelcraft reel and hose
- 2 Spray gun
- 3 12 VDC power cord and electric
- 4 DOT approved nylon tubing
- 5 Main control box
- 6 5 gal antibacterial tank
- 7 Ball valve and brass fittings
- 8 Quad-spray manhole roller  
Not shown
- 9 Spray gun nozzles  
Not shown

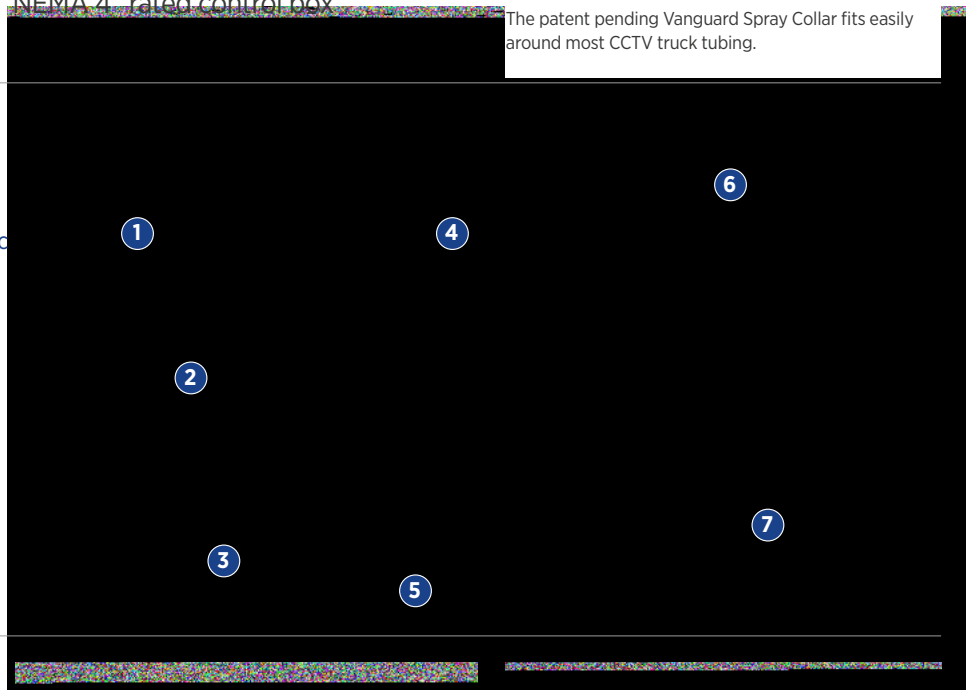

## Available Systems

### JT System

- Main control box
- Quad-spray manhole roller
- Reelcraft reel: 50' of 1/2" hose
- 5 gal antibacterial storage tank
- Complete installation kit

### CCTV System

- Main control box
- Reelcraft reel: 35' of 3/8" hose
- 5 gal cleaning concentrate tank
- Complete installation kit
- Custom-fit water tank (optional)



The spray system also provides the water volume, cleaning, and killing power required for effective SSO clean up.



The Vanguard Spray Collar can mount easily onto most CCTV vehicles.

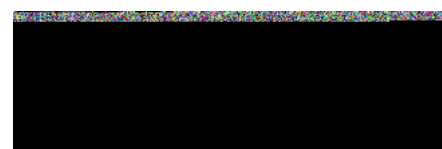

The system is ideal for cleaning work sites where children may be present.

# Manhole & Safety Equipment

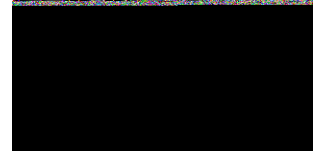

## DEVIT SYSTEM

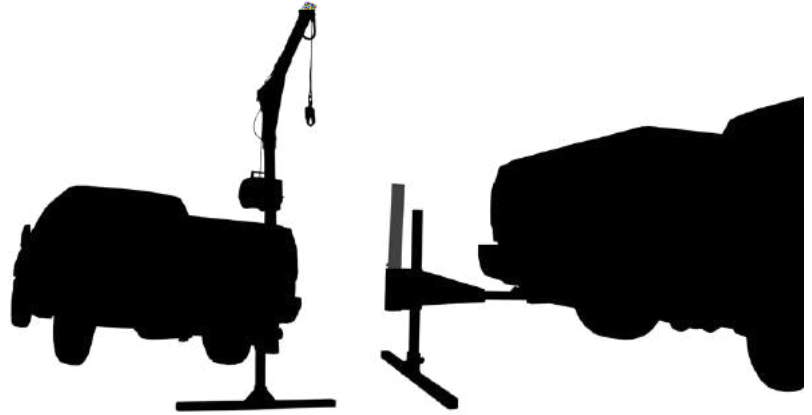
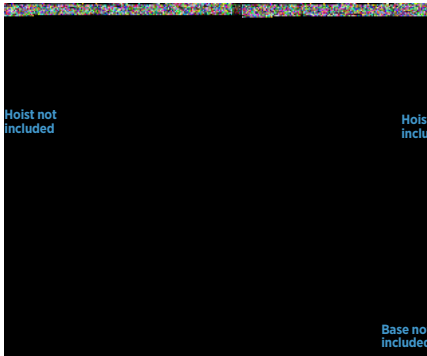

## LIFEGUARD SYSTEM



## FALL ARREST POST SYSTEMS



## SAFETY ACCESSORIES



## GAS MONITOR



## Sonectics®

Portable, battery-operated and reliable wireless communication solutions for teams of 2 to 20

- Listen-through technology
- Advanced hearing protection
- Rugged and durable
- Custom colors

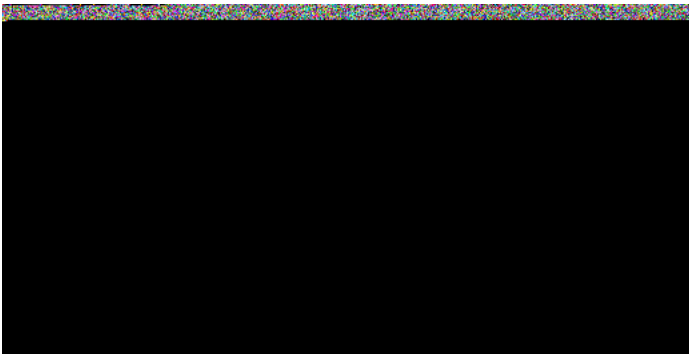
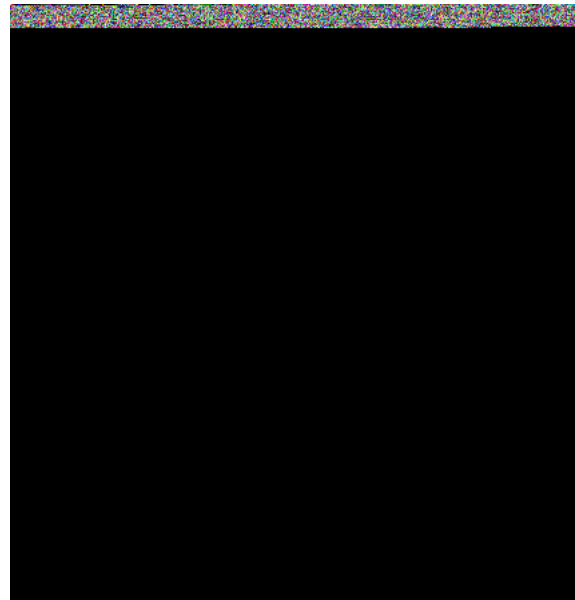
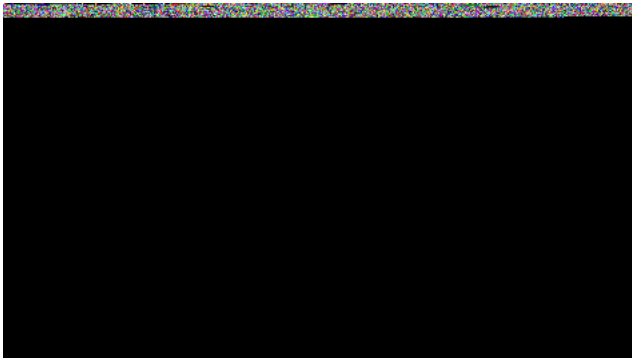

# Rental Equipment

## Benefits of Renting with BEC

- Daily, weekly, monthly and long-term rental options
- Large selection of makes and models from leading manufacturers
- Equipment is serviced routinely and used machines are well-maintained
- Rental equipment is readily available and delivered promptly
- Unmatched customer service, product knowledge and technical expertise

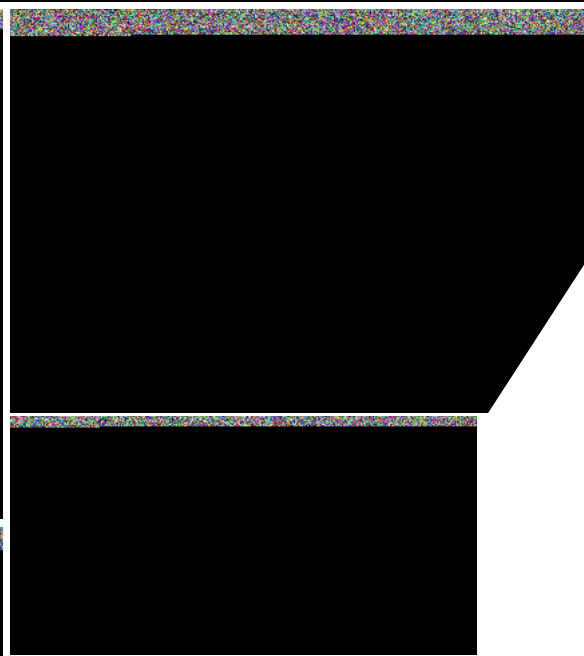
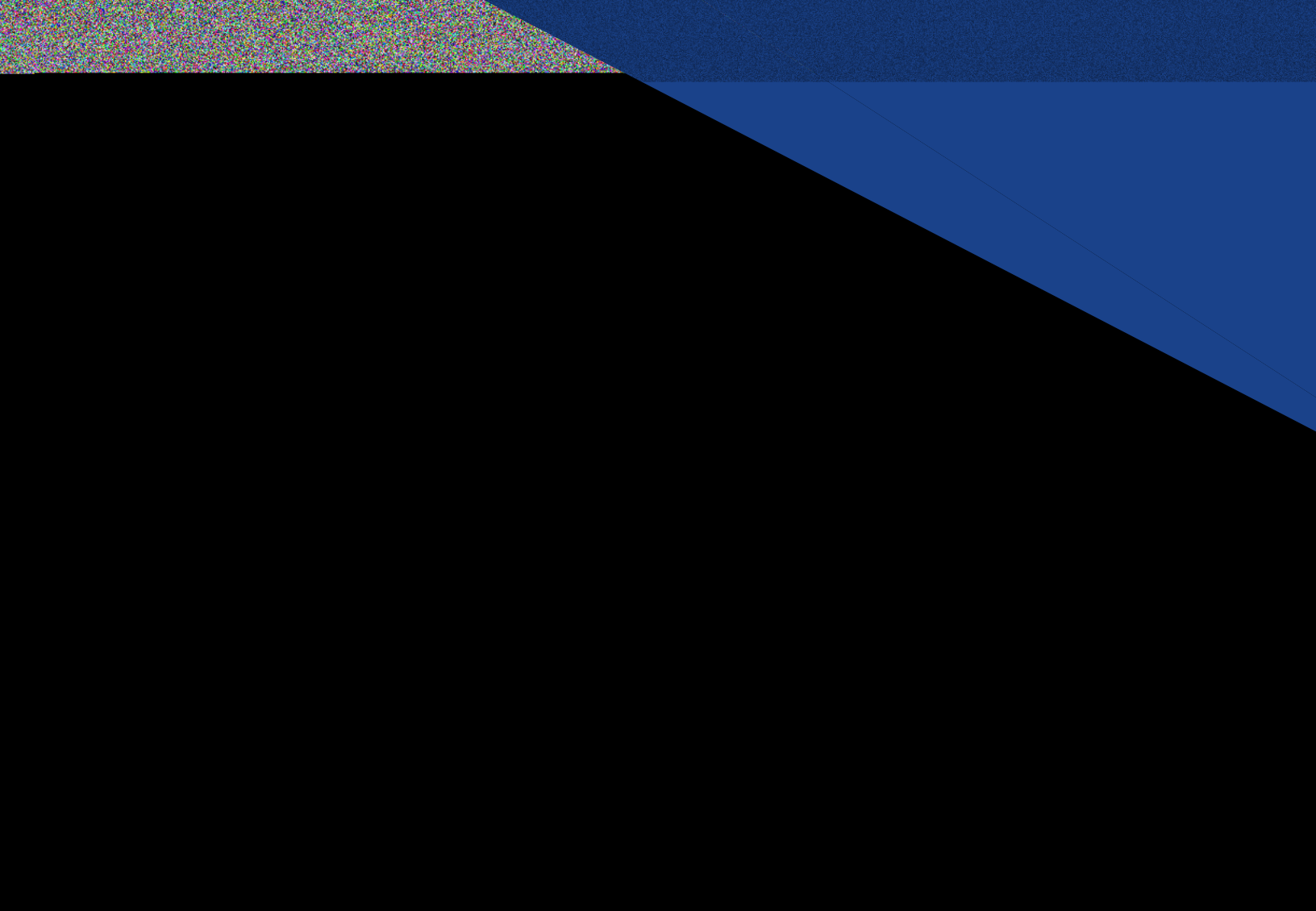

# Camera Services

- Factory certified technicians
- Short turnaround
- Pickup and delivery of parts and equipment
- Loaner and rental equipment available
- Used equipment available
- State-of-the-art repair center
- Servicing Cues, Ratech, Ridgid, Rausch, and Ibak cameras

28,000 ft<sup>2</sup> facility, custom parts, and design custom fabrication



## Redi Kit

- 1 Digital high-resolution wide angle web camera
- 2 Diagnostic test box
- 3 Video cables + adapters  
Not shown - under foam
- 4 Rugged weather proof storage case
- 5 Footage test box
- 6 Digital multi-meter

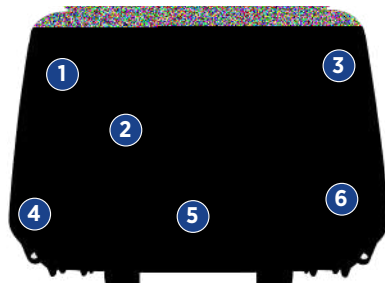

# Full-Maintenance Service & Repairs

## Experience Meets Technical Skill

- Full-Service Maintenance and Repairs on all products, regardless of make or model
- 24 hours a day. 7 days a week.
- Mobile technicians available for field service calls



### Preventative Maintenance Program Advantages

Immediate return with operations

Critical inspections completed on regular basis

Extended equipment life

Reduction in unexpected breakdowns

Improved resale value

Improved safety for operators



**Preventative Maintenance Programs available for mechanical street sweepers, pure vacuum street sweepers, and leaf collectors.**

# Reconditioning

**Each piece of equipment is inspected and tested before starting the reconditioning process**

- Our process includes:
  - Complete disassembly and inspection
  - All wearable items and hoses replaced
  - All subassemblies rebuilt
  - All components are painted and sandblasted prior to assembly
  - New decals if requested

Refurbished WACHS



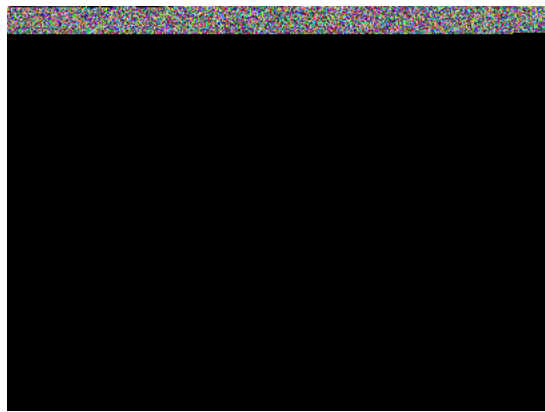
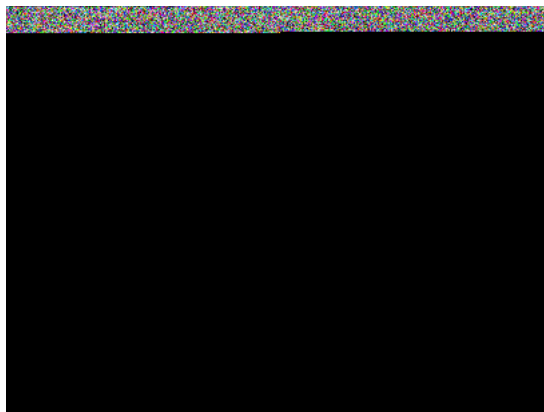
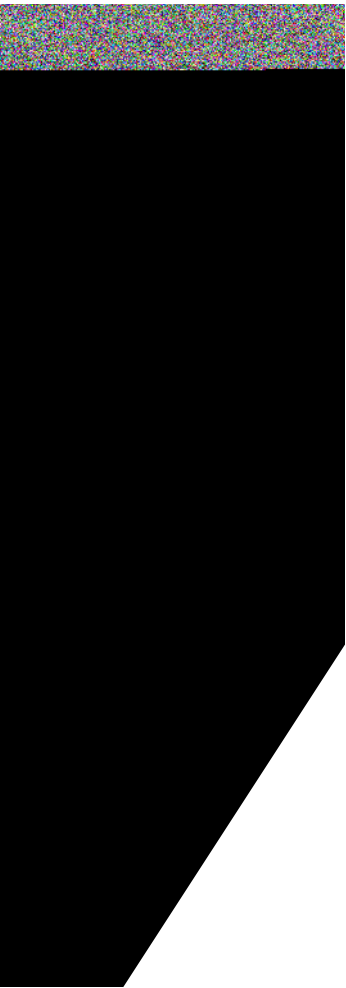
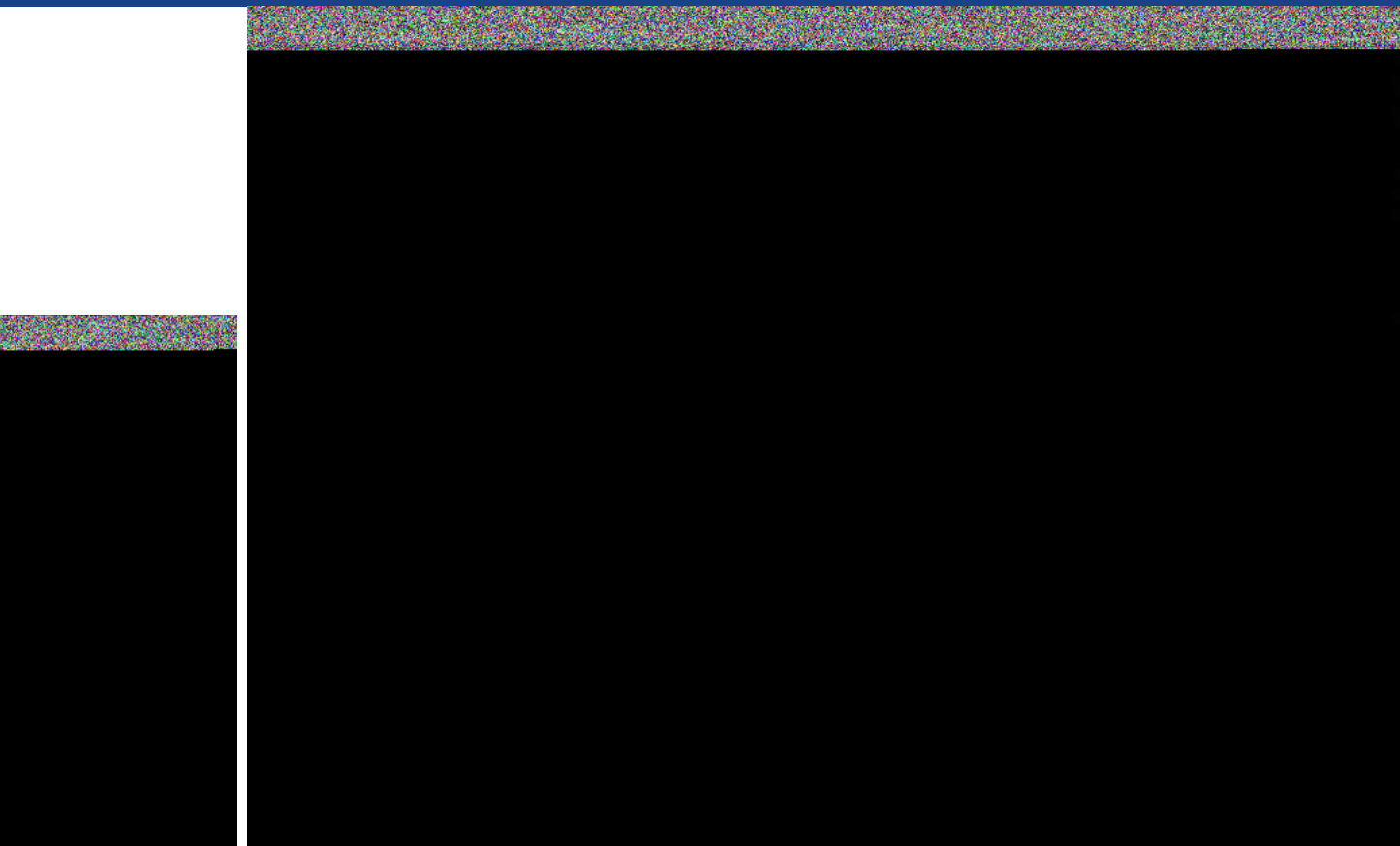

Each machine is set back to manufacturer specifications and all part replacements are with new OEM parts. After the unit is restored, it goes through an extensive 12 hour minimum of operation and testing to ensure optimal performance of the machine. BEC warranties are available for reconditioned units.

Refurbished Street Sweeper

# Custom Builds & Fabrication

Fabrication Equipment
Fronius TPS 400I Pulse MIG Welder
Haas Milling Machine
5' x 8' CNC Plasma Table
Acer Hand Lathe with 14" swing and 42" bed and digital readout
Acer End Mill with digital readout
Machine Press
Leister plastic welders
Sheer Brake
12' Metal Brake
CNC Mill

## Specializing in metal and plastics fabrication and welding

- Outfit any specialty equipment and make modifications to fit your needs
- Offering the following services:
  - Metal cutting and bending
  - CNC mill work
  - CAD drawing
  - Planning and design
  - Troubleshooting
  - Soldering and brazing

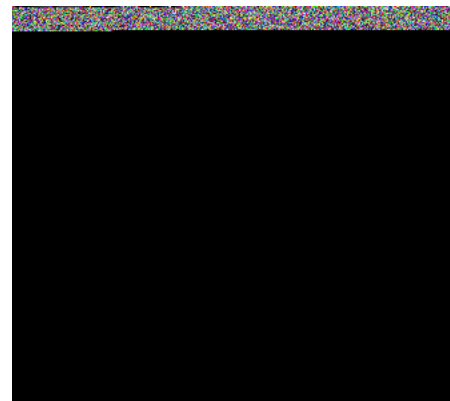
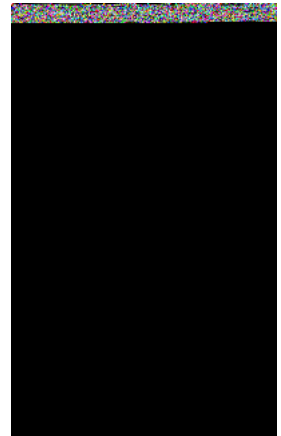

# Parts & Accessories

**Over  
10,000 parts  
& accessories  
available**

- Extensive inventory of equipment parts and OEM equipment parts
- Available in-house and for delivery
- Authorized dealership for 15 plus manufacturers
- Strategically located service centers for maintenance support
- Pickup, delivery and field calls available

## Sample Parts List

Hydro excavation spray guns and nozzles

High pressure washdown guns

Jetting nozzles

Manhole protection rings

Kuriyama hosing, couplings and fittings

KuriKrimp Crimper



Serving Indiana, Kentucky, Michigan, and Ohio.

**BrownEquipment.net | (800) 747-2312**

Serving Indiana, Kentucky, Michigan, and Ohio.